

Features

The Rolling Hills features GS Web Technology which includes the highest steel content and the strongest connection materials in the industry, including a steel-wire core in our edge ropes and connection points crushed in place with over **75 tons** of pressure to ensure long life of the games and maximum safety for the children.

GS Web Nets help bring movement, balance, exercise and fun back into the playground.

Ages : 5 to 12 years
Capacity : 16 children
Size : L4.14m x W2.61m x H2.01m
Use zone : L7.81m x W5.61m



▲ Completed Net

Safety area

The requirements for space and safety clearances are taken from BS-EN 1176-1 / ASTM-F1487.
 The use zone for stationary play equipment shall extend no less than 72 in. (1830mm) from all sides of the play structure.

Fall Height : 2010mm (from surface)

The Fall height on the external surface of a pyramid shaped space net is the highest point attainable on the edge of the structure where an unimpeded fall to the protective surface is possible. This height is based on the center of gravity height of the maximum user.

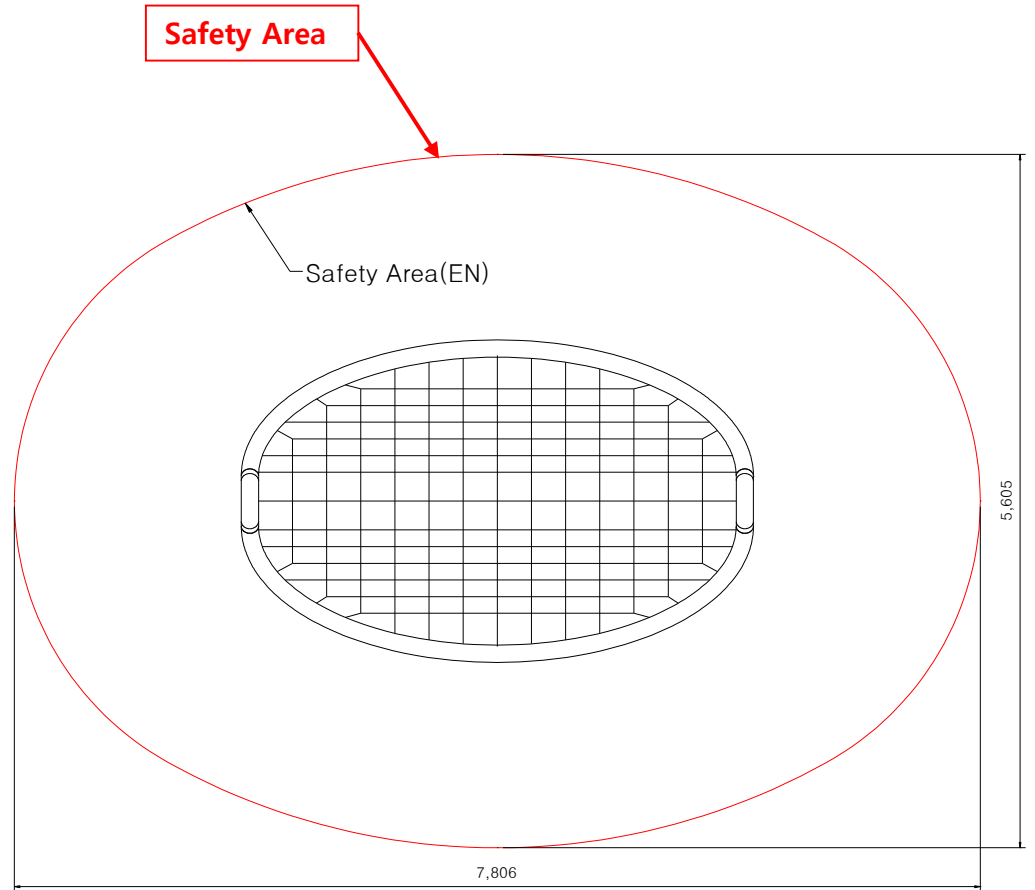
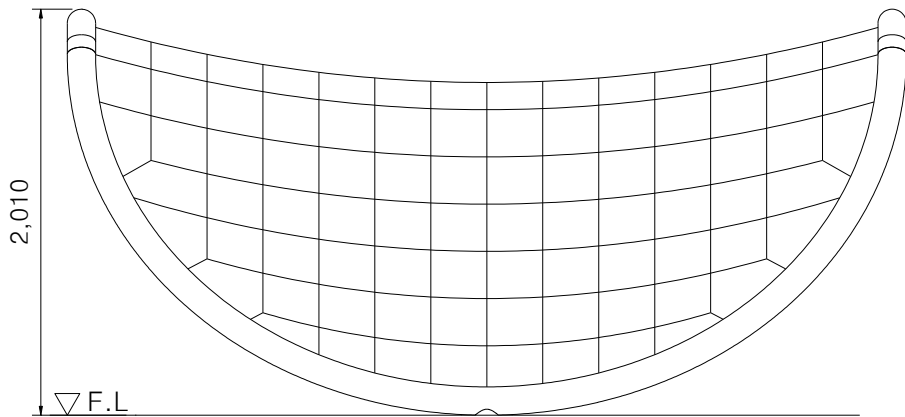

▲ Fall Height and safety area

!Attention

Please refer to following details for foundation work.
Base plates are welded to the Rolling Hill's pipe. After assembling pipes and nets, fix the structure on the concrete.

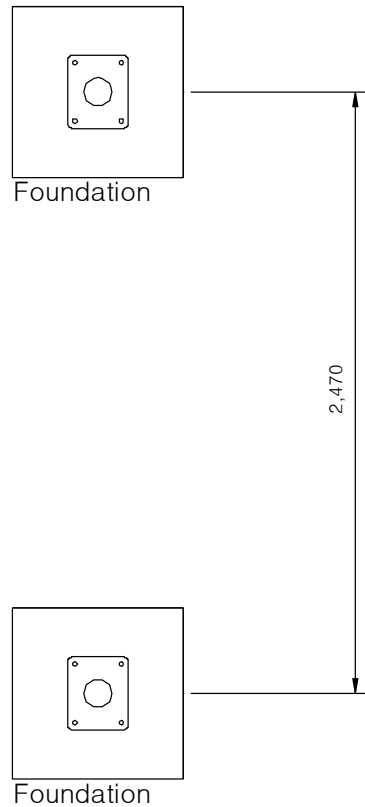

Foundation Detail Foundation

Pouring Concrete

Pour concrete* into wooden support frame until flush to top edge
Allow 3-5 days for concrete to cure before proceeding to next step.

*Concrete is to be wet concrete with minimum 25 MPA / 3500PSI.

****See the drawing**

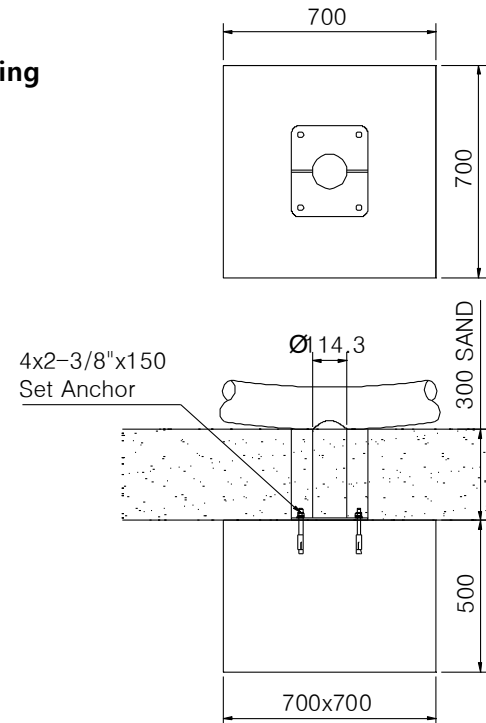

Overall Assembly

Assemble the parts in the following order:

1. Check names of the parts.
- From "1" to "2" are Pipe's name.
2. To prevent any confusion, Divide all parts into groups,
Outside and Inside as below.

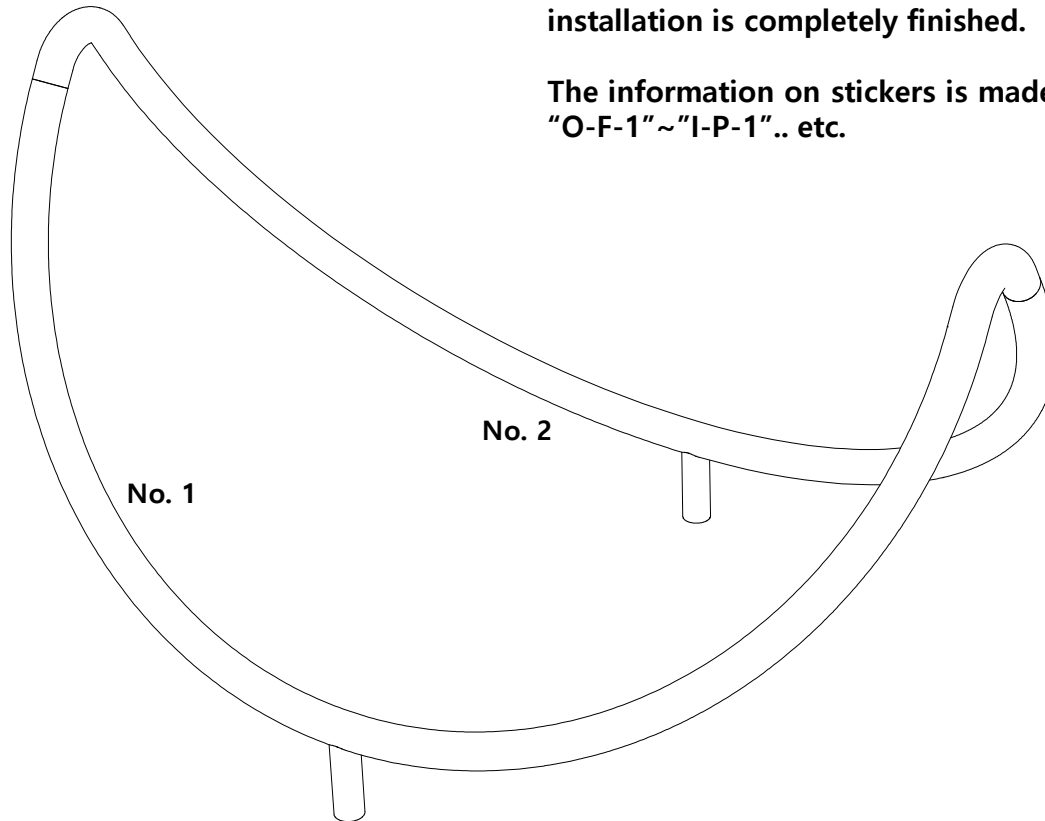

!Attention

It is very important to keep the stickers attached on the parts on until the installation is completed.

If the stickers are detached during the installation, it might be difficult to check whether the parts are correctly assembled in correct order and position.

Quite much recommended to take care that no sticker is detached before installation is completely finished.

The information on stickers is made up of part name and number such as "O-F-1" ~ "I-P-1".. etc.

Overall Assembly

Assemble the pipes in alphabetical order.

1. Check the pipes' numbers on Stickers on them.
2. As below picture, Line up the pipes and Connect the pipe to the next pipe
3. Set the holes on the pipe and put bolts into the holes.
4. Fasten the bolts.
5. Repeat with the others in the same way.

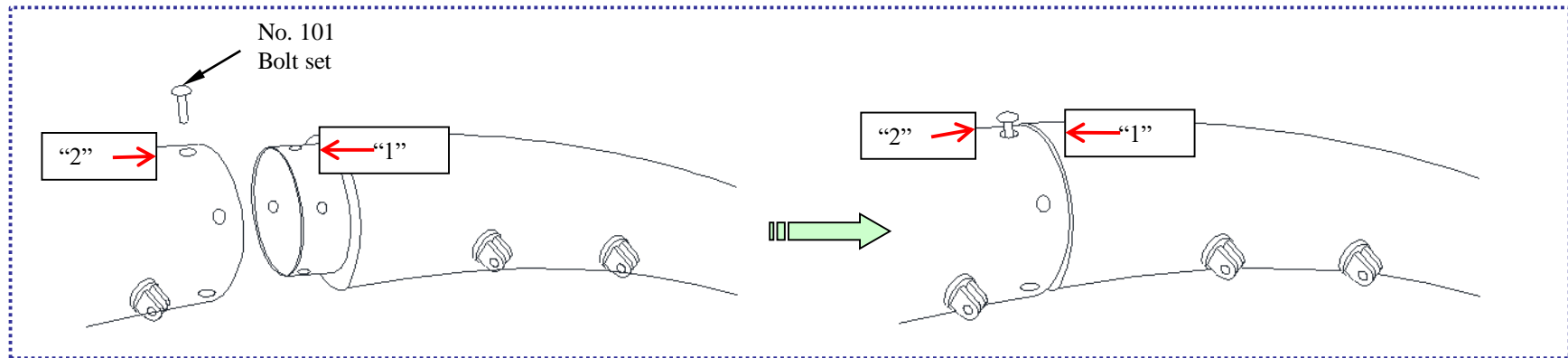

Overall Assembly

Assemble the parts in the following order:

1. Check the net's name. There are 6 set net from Net A.
2. Attach the net to the proper location of pipe in order as below picture.

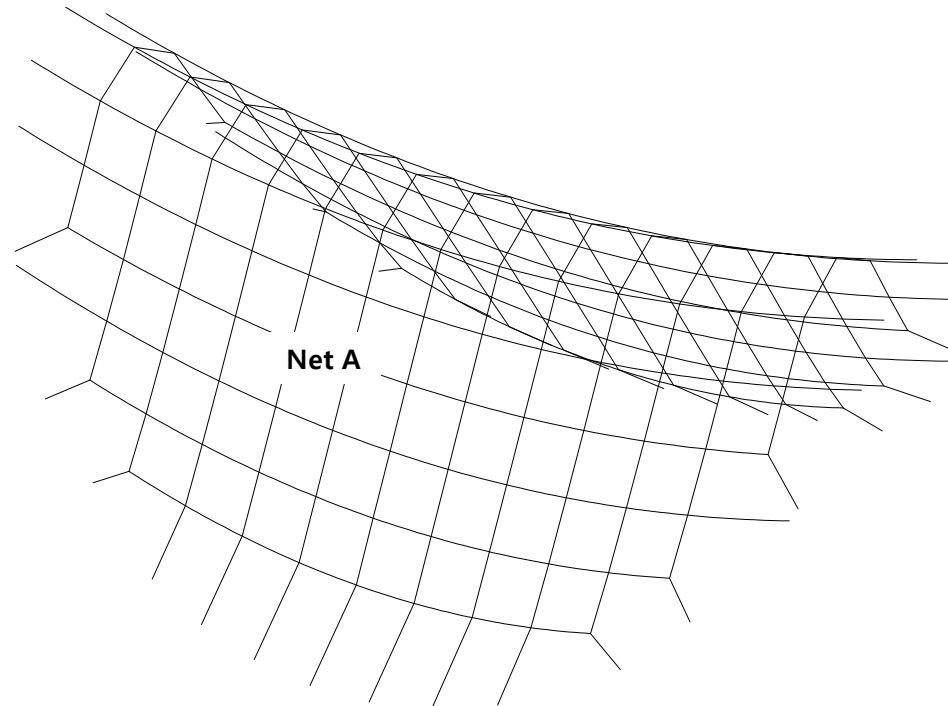
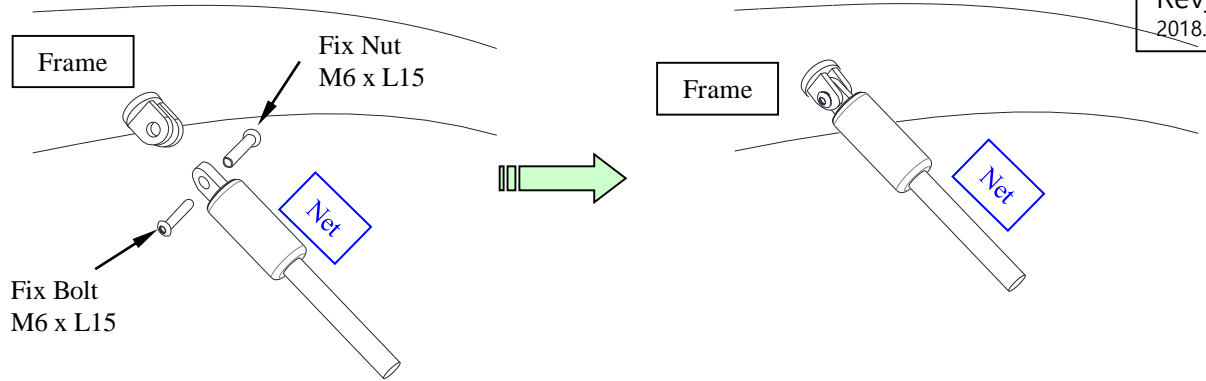

A. General safety measures

On the playground there should be a sign(pictogram) giving the following information:

- a) general emergency telephone number;
- b) telephone number to contact maintenance personnel;
- c) name of the playground;
- d) address of playground; and
- e) other relevant local information, if applicable.

The entry, exit and emergency paths to and from a playground, intended for use by the public and emergency services, should be accessible and free of obstacles at all times.

NOTE Attention is drawn to local regulations.

B. Procedures

Defects that occur during operation and which put safety at risk should be corrected without delay. If this is not possible, the equipment should be secured against use e.g. by immobilization or removal.

There should be written operational procedures covering the measures to be taken in the event of accidents, fire and the like.

Until unsafe equipment is repaired and released for use, access by the public should be prevented. Information about accidents brought to the attention of the manager should be recorded on a form that includes the following details:

- a) date and time of accident;
- b) age and sex of victim and clothing worn, including footwear;
- c) equipment involved;
- d) number of children on site at the time of the accident;
- e) description of accident;
- f) injury sustained including part(s) of body affected;
- g) action taken;
- h) witness statements;
- i) any subsequent equipment modification;
- j) weather conditions; and
- k) any other relevant information.

C. Routine maintenance

To reduce accidents, the owner or operator should ensure that an appropriate routine maintenance schedule is established, implemented and maintained. This should take into account local conditions and the manufacturer's instructions that can affect the necessary inspection frequency. The schedule should list the components to be maintained and should also give procedures for dealing with complaints and breakdowns.

The routine maintenance of playground equipment and surfaces should consist of preventative measures to maintain their level of safety, performance and compliance with the relevant part(s) of EN 1176. Such measures should include:

- a) tightening of fastenings;
- b) re-painting and re-treatment of surfaces;
- c) maintenance of any impact attenuating surfaces;
- d) lubrication of bearings;
- e) marking of equipment to signify loose fill finished surface level;
- f) cleaning;
- g) removal of broken glass and other debris or contaminants;
- h) restoring loose fills to the correct level; and
- i) maintenance of free space areas.

D. Corrective maintenance

Corrective maintenance should include measures to correct defects, or to re-establish the necessary levels of safety of the playground equipment and surfaces. Such measures should include:

- a) replacement of fastenings;
- b) welding of welding repairs;
- c) replacement of worn or defective parts; and
- d) replacement of defective structural components.

E. Personal safety

Repairs during operation that could put the safety of maintenance personnel of the public at risk, should be avoided.

F. Equipment alterations

Alterations to parts of a piece of equipment or structure that could affect the essential safety of the equipment should only be carried out after consultation with the manufacturer or a competent person.